

Turmdrehkran

Tower Crane / Grue à tour / Gru a torre / Grúa torre /
Guindaste de torre / Башенный поворотный кран

340 EC-B 12

▶ 340 EC-B 12

340 EC-B 16

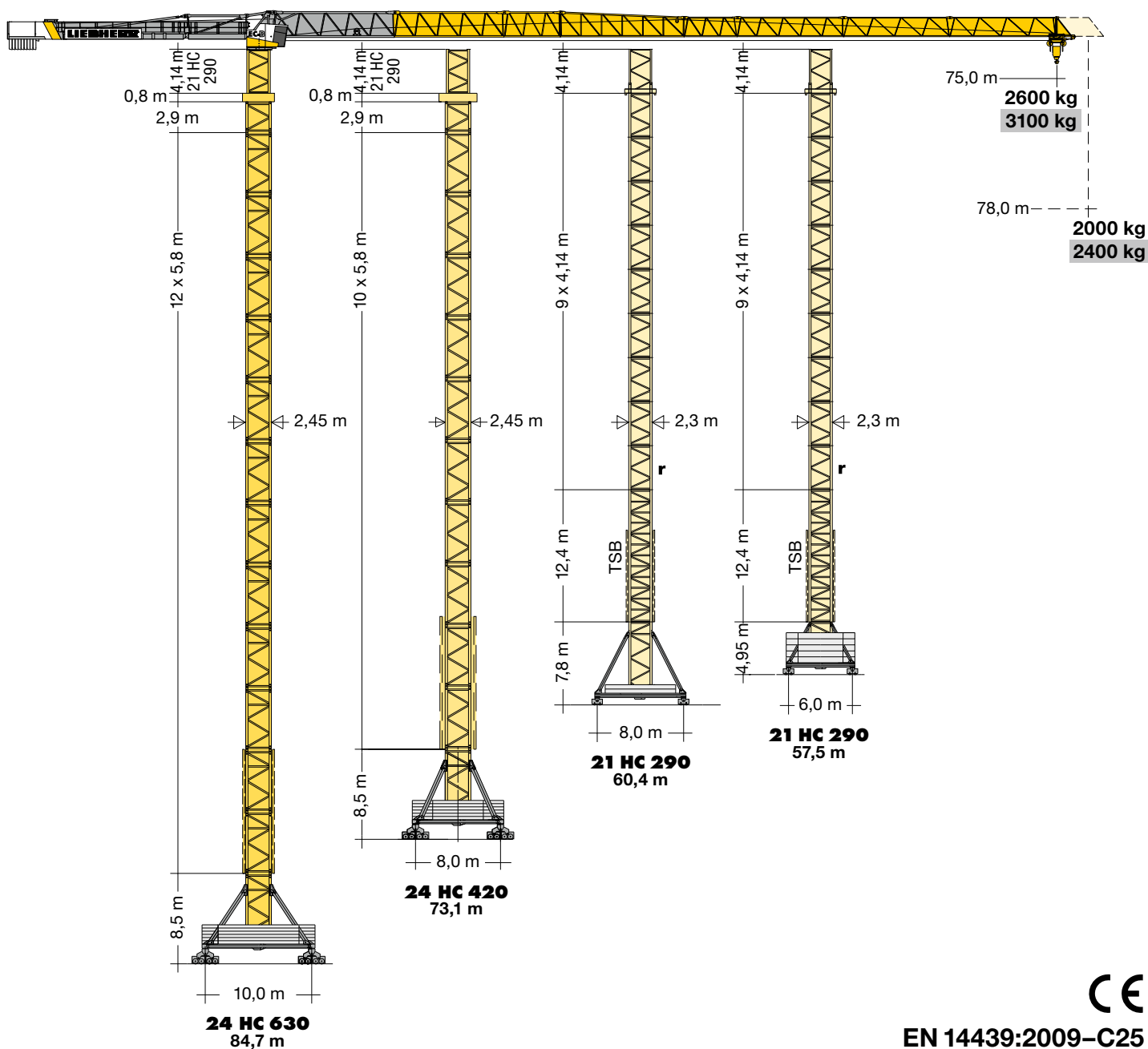

LIEBHERR

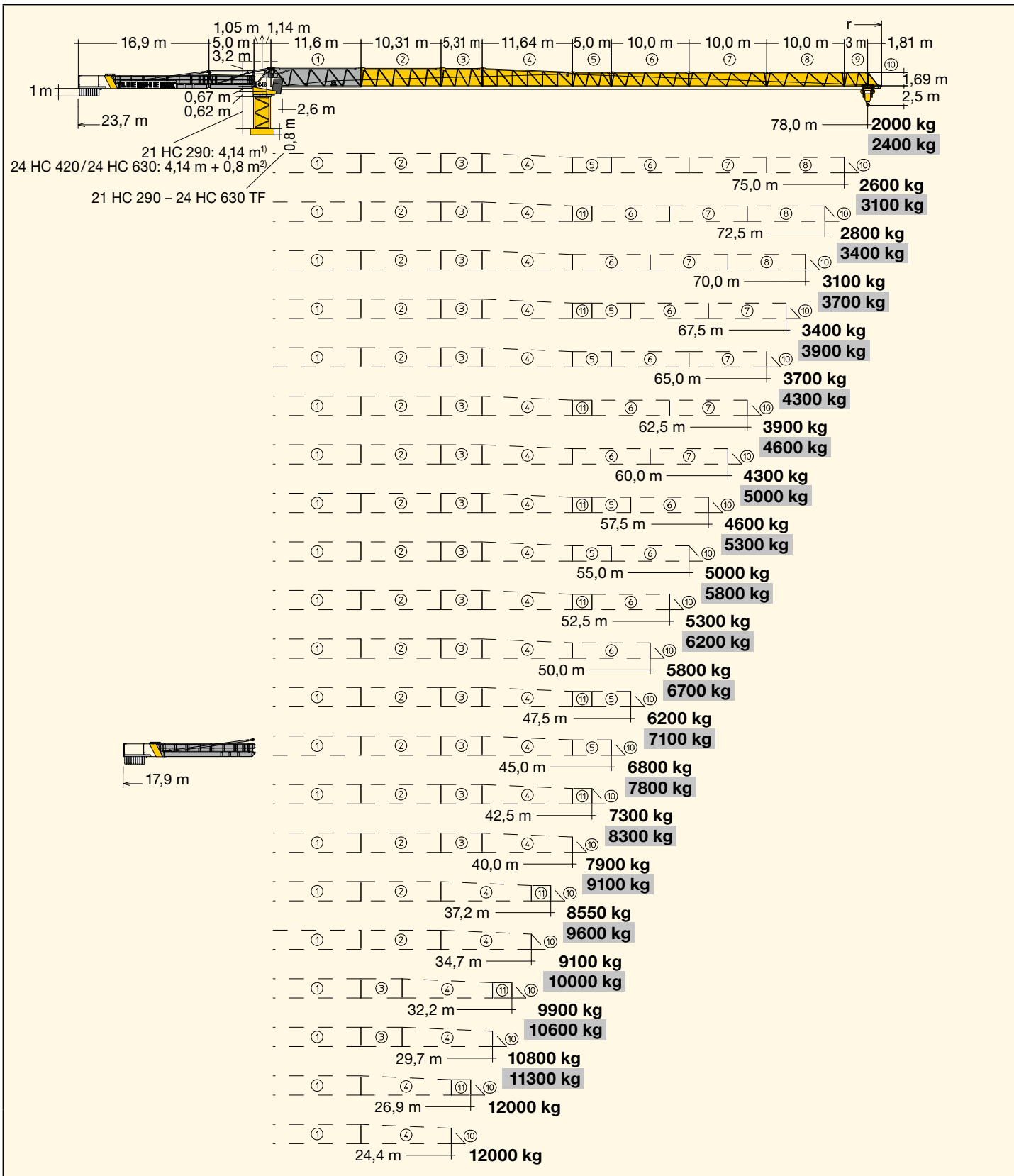

¹⁾ Turmstück oder Kletterturmstück / Tower section or climbing tower section / Élément de mât ou élément de mât télescopable / Elemento torre oppure elemento torre telescopabile / Tramo torre o tramo torre trepable / Segmento de torre ou segmento de torre para ascensão / Башенная секция или секция наращивания

²⁾ Turmstück 21 HC 290 + Übergangsrahmen 21 HC 290 – 24 HC 630 TF / Tower section 21 HC 290 + transition frame 21 HC 290 – 24 HC 630 TF / Élément de mât 21 HC 290 + cadre de raccordement 21 HC 290 – 24 HC 630 TF / Elemento di torre 21 HC 290 + Adattatore torre 21 HC 290 – 24 HC 630 TF / Tramo torre 21 HC 290 + Marco de transición 21 HC 290 – 24 HC 630 TF / Segmento de torre 21 HC 290 + Quadro de transição 21 HC 290 – 24 HC 630 TF / Башенная секция 21 HC 290 + Переходная рама 21 HC 290 – 24 HC 630 TF

m	r	m/kg	m/kg																	340 EC-B 12						
			24,4	26,9	29,7	32,2	34,7	37,2	40,0	42,5	45,0	47,5	50,0	52,5	55,0	57,5	60,0	62,5	65,0	67,5	70,0	72,5	75,0	78,0		
78,0 (r=79,6)	2,6 - 18,5 12000	8780	7850	7000	6370	5830	5360	4910	4560	4240	3960	3710	3480	3280	3090	2910	2760	2610	2470	2350	2230	2120	2000			
75,0 (r=76,6)	2,6 - 21,0 12000	10170	9120	8160	7440	6830	6300	5780	5380	5020	4710	4420	4160	3920	3710	3510	3330	3160	3000	2860	2730	2600				
72,5 (r=74,1)	2,6 - 21,5 12000	10430	9350	8370	7630	7000	6460	5930	5520	5150	4820	4530	4260	4020	3800	3600	3410	3240	3080	2940	2800					
70,0 (r=71,6)	2,6 - 22,0 12000	10730	9650	8650	7900	7270	6710	6170	5750	5380	5040	4740	4470	4220	3990	3780	3590	3420	3250	3100						
67,5 (r=69,1)	2,6 - 22,5 12000	11010	9920	8910	8150	7500	6940	6390	5960	5580	5240	4930	4650	4390	4160	3950	3750	3570	3400							
65,0 (r=66,6)	2,6 - 23,0 12000	11280	10170	9150	8380	7720	7150	6590	6150	5760	5410	5090	4810	4550	4310	4090	3890	3700								
62,5 (r=64,1)	2,6 - 23,5 12000	11520	10370	9300	8500	7820	7230	6650	6210	5810	5450	5130	4830	4570	4330	4100	3900									
60,0 (r=61,6)	2,6 - 24,0 12000	11790	10640	9570	8770	8080	7490	6900	6450	6040	5680	5350	5050	4780	4530	4300										
57,5 (r=59,1)	2,6 - 24,5 12000	12000	10860	9760	8940	8230	7620	7030	6560	6140	5770	5430	5130	4850	4600											
55,0 (r=56,6)	2,6 - 25,0 12000	12000	11110	9990	9160	8440	7820	7210	6740	6310	5940	5590	5280	5000												
52,5 (r=54,1)	2,6 - 25,5 12000	12000	11320	10160	9290	8550	7900	7280	6790	6350	5970	5620	5300													
50,0 (r=51,6)	2,6 - 26,0 12000	12000	11570	10400	9520	8770	8120	7490	6990	6550	6160	5800														
47,5 (r=49,1)	2,6 - 26,0 12000	12000	11580	10420	9550	8810	8160	7530	7030	6590	6200															
45,0 (r=46,6)	2,6 - 26,5 12000	12000	11820	10660	9790	9040	8380	7750	7250	6800																
42,5 (r=44,1)	2,6 - 26,5 12000	12000	11820	10680	9820	9080	8430	7800	7300																	
40,0 (r=41,6)	2,6 - 27,0 12000	12000	12000	10870	9980	9210	8550	7900																		
37,2 (r=38,8)	2,6 - 27,0 12000	12000	12000	10870	9980	9220	8550																			
34,7 (r=36,3)	2,6 - 27,0 12000	12000	12000	10810	9890	9100																				
32,2 (r=33,8)	2,6 - 27,0 12000	12000	12000	10820	9900																					
29,7 (r=31,3)	2,6 - 27,0 12000	12000	12000	10800																						
26,9 (r=28,5)	2,6 - 26,9 12000	12000	12000																							
24,4 (r=26,0)	2,6 - 24,4 12000	12000																								

LM 1

m	r	m/kg	m/kg																	340 EC-B 12						
			24,4	26,9	29,7	32,2	34,7	37,2	40,0	42,5	45,0	47,5	50,0	52,5	55,0	57,5	60,0	62,5	65,0	67,5	70,0	72,5	75,0	78,0		
78,0 (r=79,6)	2,6 - 19,5 12000	9520	8590	7720	7070	6510	6020	5540	5170	4840	4540	4270	4020	3800	3590	3400	3230	3070	2920	2780	2660	2530	2400			
75,0 (r=76,6)	2,6 - 22,0 12000	10840	9830	8890	8180	7560	7020	6490	6070	5700	5360	5060	4780	4530	4300	4090	3890	3710	3540	3380	3240	3100				
72,5 (r=74,1)	2,6 - 22,5 12000	11100	10100	9150	8430	7810	7260	6730	6300	5920	5580	5270	4990	4730	4490	4270	4070	3890	3710	3550	3400					
70,0 (r=71,6)	2,6 - 23,0 12000	11350	10340	9390	8670	8040	7480	6940	6510	6120	5770	5460	5170	4910	4660	4440	4230	4040	3870	3700						
67,5 (r=69,1)	2,6 - 23,5 12000	11580	10530	9550	8800	8160	7590	7030	6590	6200	5840	5520	5220	4960	4710	4480	4270	4080	3900							
65,0 (r=66,6)	2,6 - 24,0 12000	11820	10790	9820	9080	8430	7860	7300	6860	6460	6100	5770	5470	5200	4950	4710	4500	4300								
62,5 (r=64,1)	2,6 - 24,5 12000	12000	11000	10010	9260	8600	8020	7450	7000	6590	6230	5890	5590	5310	5050	4820	4600									
60,0 (r=61,6)	2,6 - 25,0 12000	12000	11230	10240	9490	8830	8250	7670	7210	6800	6430	6090	5780	5500	5240	5000										
57,5 (r=59,1)	2,6 - 25,5 12000	12000	11420	10410	9640	8960	8360	7780	7310	6890	6510	6170	5850	5570	5300											
55,0 (r=56,6)	2,6 - 26,0 12000	12000	11640	10650	9880	9210	8620	8030	7560	7140	6760	6410	6090	5800												
52,5 (r=54,1)	2,6 - 26,5 12000	12000	11840	10830	10050	9370	8770	8170	7690	7260	6880	6520	6200													
50,0 (r=51,6)	2,6 - 27,0 12000	12000	12000	11030	10250	9570	8960	8360	7880	7450	7060	6700														
47,5 (r=49,1)	2,6 - 27,0 12000	12000	12000	11040	10270	9590	8990	8400	7920	7490	7100															
45,0 (r=46,6)	2,6 - 27,5 12000	12000	12000	11270	10520	9870	9280	8700	8230	7800																
42,5 (r=44,1)	2,6 - 27,5 12000	12000	12000	11280	10560	9920	9340	8760	8300																	
40,0 (r=41,6)	2,6 - 28,0 12000	12000	12000	11490	10810	10200	9660	9100																		
37,2 (r=38,8)	2,6 - 28,0 12000	12000	12000	11480	10780	10160	9600																			
34,7 (r=36,3)	2,6 - 28,0 12000	12000	12000	11430	10670	10000																				
32,2 (r=33,8)	2,6 - 28,0 12000	12000	12000	11400	10600																					
29,7 (r=31,3)	2,6 - 28,0 12000	12000	12000	11300																						
26,9 (r=28,5)	2,6 - 26,9 12000	12000	12000																							
24,4 (r=26,0)	2,6 - 24,4 12000	12000																								

Load-Plus

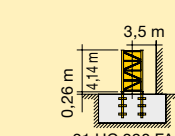
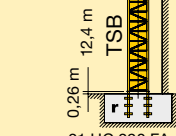
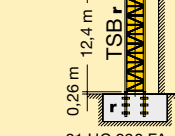
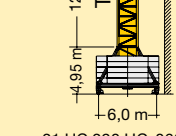
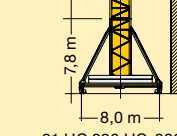
4,14 m		21 HC 290				
4,14 m	4,14 m + 2,07 m	C 25				
10	9 + 1	-	57,0 ^{*)4)}	-	-	-
9	8 + 1	40,4 ^{*)}	54,9 ^{*)4)}	-	-	57,5 ^{*)3)}
8	7 + 1	38,3 ^{*)}	50,8 ^{*)}	-	-	55,5 ^{*)}
7	6 + 1	36,3	48,7 ^{*)}	-	-	53,4 ^{*)}
6	5 + 1	34,2	46,6	-	-	51,3
5	4 + 1	32,1	44,5	69,4 ^{*)}	-	49,2
4	3 + 1	30,1	42,5	67,3 ^{*)}	-	47,2
3	2 + 1	28,0	40,4	65,3	-	45,1
2	1 + 1	25,9	38,3	63,2	-	43,0
1	0 + 1	23,8	36,3	61,1	-	41,0
0		21,8	34,2	59,0	-	38,9
		19,7	32,1	57,0	-	36,8
		17,6	30,1	54,9	-	34,8
		15,6	28,0	52,8	-	32,7
		13,5	25,9	50,8	-	30,6
		11,4	23,9	48,7	-	28,5
		9,4	21,8	46,6	-	26,5
		7,3	19,7	44,5	-	24,4
		5,2	17,6	42,5	-	22,3
		3,2	15,6	40,4	-	20,3
		m	m	m	m	m
						
		21 HC 290 FA	21 HC 290 FAr	21 HC 290 FAr	21 HC 290 UC-0600	21 HC 290 UC-0800

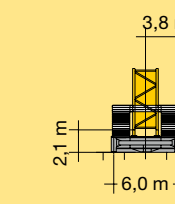
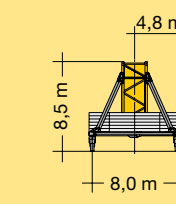
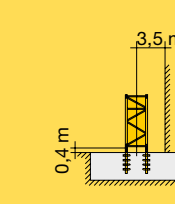
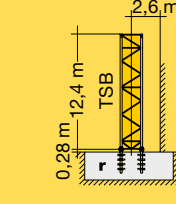
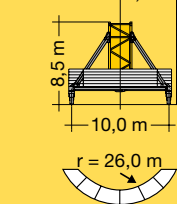
5,8 m		24 HC 420		24 HC 420 / 24 HC 630		24 HC 630	
5,8 m	5,8 m + 2,9 m	C 25					
13	12 + 1	-	-	82,4 ^{*)8)}	-	91,7 ^{*)}	-
12	11 + 1	-	-	79,5 ^{*)7)}	-	88,8 ^{*)}	-
11	10 + 1	-	-	76,6 ^{*)7)}	-	85,9	84,7 ^{*)}
10	9 + 1	66,7 ^{*)}	73,1 ^{*)}	73,7 ^{*)6)}	-	83,0	81,8 ^{*)}
9	8 + 1	63,8 ^{*)}	70,2 ^{*)}	70,8 ^{*)6)}	-	80,1	78,9
8	7 + 1	60,9	67,3	67,9 ^{*)5)}	-	77,2	76,0
7	6 + 1	58,0	64,4	65,0 ^{*)}	-	74,3	73,1
6	5 + 1	55,1	61,5	62,1 ^{*)}	-	71,4	70,2
5	4 + 1	52,2	58,6	59,2	-	68,5	67,3
4	3 + 1	49,3	55,7	56,3	-	65,6	64,4
3	2 + 1	46,4	52,8	53,4	-	62,7	61,5
2	1 + 1	43,5	49,9	50,5	-	59,8	58,6
1	0 + 1	40,6	47,0	47,6	-	56,9	55,7
0		37,7	44,1	44,7	-	54,0	52,8
		34,8	41,2	41,8	-	51,1	49,9
		31,9	38,3	38,9	-	48,2	47,0
		29,0	35,4	36,0	-	45,3	44,1
		26,1	32,5	33,1	-	42,4	41,2
		23,2	29,6	30,2	-	39,5	38,3
		20,3	26,7	27,3	-	36,6	35,4
		17,4	23,8	24,4	-	33,7	32,5
		14,5	20,9	21,5	-	30,8	29,6
		11,6	18,0	18,6	-	27,9	26,7
		8,7	15,1	15,7	-	25,0	23,8
		5,8	12,2	12,8	-	22,1	20,9
				9,9	-	19,2	18,0
				7,0	-	16,3	15,1
		m	m	m	m	m	m
							
		24 HC 420 CB-0600	24 HC 630 UC-0800	24 HC 420 FA / 24 HC 630 FA	24 HC 630 FAr	24 HC 630 UC-1000m	

Turmstücke 24 HC 630 müssen am Turmfuß eingebaut werden. Details siehe Bedienungsanleitung. / Tower sections 24 HC 630 must be installed on the tower base. See operating manual for further details. / Les éléments de mât 24 HC 630 doivent être montés en pied de grue. Voir les détails dans les instructions d'emploi. / Elementi torre 24 HC 630 devono essere montati alla base torre. Si veda il manuale istruzioni per i dettagli. / Los tramos torre de la 24 HC 630 tienen que ser montados en el pie de torre. Más detalles en las instrucciones de montaje. / Segmentos de torre 24 HC 630 devem ser instalados sobre o segmento base. Para mais detalhes consultar manual de instrução. / Башенные секции 24 HC 630 должны монтироваться в основании башни. Подробную информацию смотри в инструкции по эксплуатации.

*)  3) 1 x 21 HC 290 TS-0414cr
 4) 2 x 21 HC 290 TS-0414cr
 5) 1 x 24 HC 630 TS-0580c
 6) 2 x 24 HC 630 TS-0580c
 7) 3 x 24 HC 630 TS-0580c
 8) 4 x 24 HC 630 TS-0580c

Weitere Hubhöhen, Auslegerlängen sowie Klettern im Gebäude auf Anfrage. / Further hoist heights and jib lengths as well as climbing inside the building on request. / Autres hauteurs sous crochet et longueurs de flèche ainsi que hissage dans le bâtiment sur demande. / Ulteriori altezze gancho, lunghezze braccio così come telescopaggio all'interno dell'edificio: su richiesta. / Para alturas bajo gancho superiores, otros alcances y trepado en el interior del edificio, consultar. / Outras alturas de elevação, comprimentos de lança e subida no edifício: sob consulta. / Другие высоты подъема, длины стрелы и самоподъем в здании – по запросу.

r = verstärkt / reinforced / renforcé / rinforzato / reforzado / reforçado / усиленный

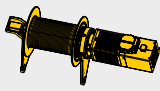
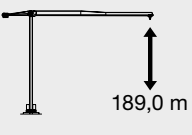
	↔ stufenlos/stepless/régl. continu/ regl. progressiva/sin escalones/ sem degraus/бесступенчатый
	kg m/min
45 kW FU WIW 260 MZ 417	5 Lagen Layers Couches Avvolgimenti Camadas Сарас Слоёв
 189,0 m max. 325,0 m ⁹⁾	1 12000 0 ↔ 20 650 0 ↔ 116

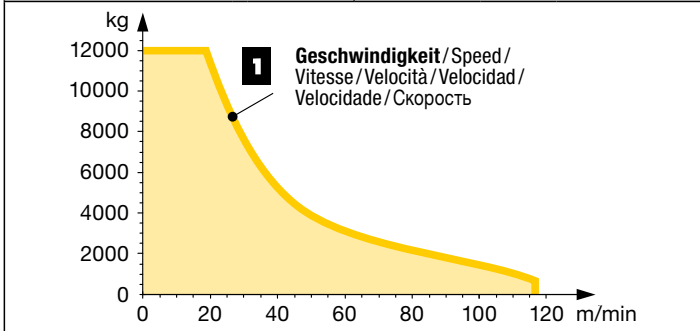

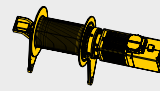
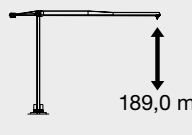
	↔ stufenlos/stepless/régl. continu/ regl. progressiva/sin escalones/ sem degraus/бесступенчатый
	kg m/min
65 kW FU WIW 280 MZ 415	5 Lagen Layers Couches Avvolgimenti Camadas Сарас Слоёв
 189,0 m max. 325,0 m ⁹⁾	1 12000 0 ↔ 28 2200 0 ↔ 116

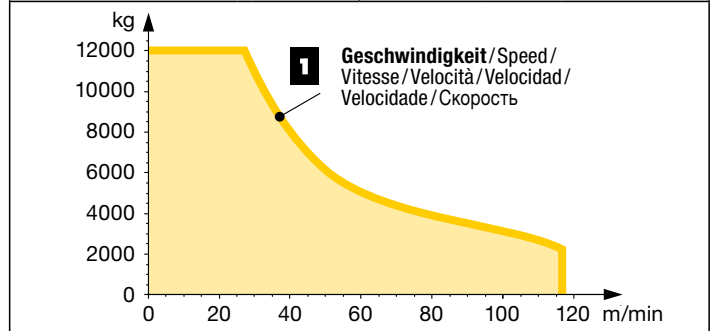

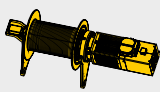
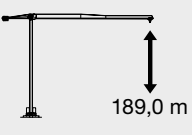

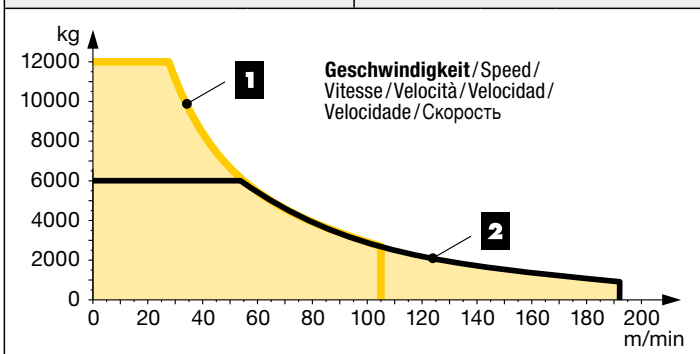
	↔ stufenlos/stepless/régl. continu/ regl. progressiva/sin escalones/ sem degraus/бесступенчатый
	kg m/min
65 kW FU [SD.shift] WIW 280 WZ 402	5 Lagen Layers Couches Avvolgimenti Camadas Сарас Слоёв
 189,0 m max. 325,0 m ⁹⁾	1 12000 0 ↔ 28 2700 0 ↔ 105 2 6000 0 ↔ 53 900 0 ↔ 192

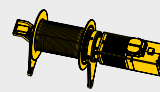
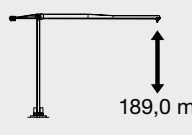

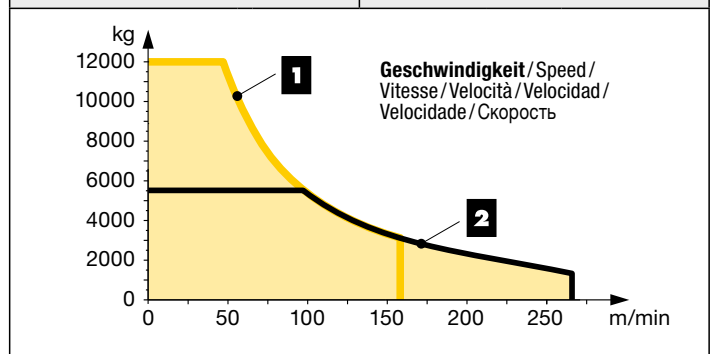
	↔ stufenlos/stepless/régl. continu/ regl. progressiva/sin escalones/ sem degraus/бесступенчатый
	kg m/min
110 kW FU [SD.shift] WIW 300 WZ 401	5 Lagen Layers Couches Avvolgimenti Camadas Сарас Слоёв
 189,0 m max. 325,0 m ⁹⁾	1 12000 0 ↔ 49 3100 0 ↔ 156 2 5500 0 ↔ 97 1400 0 ↔ 267

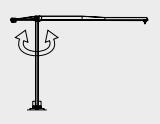
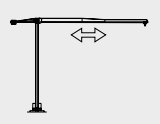
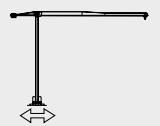

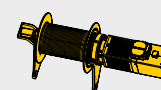



























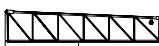

	0 ↔ U/min 0,7 sl./min tr./min	2 x 7,5 kW FU
	0 ↔ 109,0 m/min	7,5 kW FU
	25,0 m/min	4 x 7,5 kW (24 HC 420/ 24 HC 630) 2 x 7,5 kW (21 HC 290)



























			
	kVA	45 kW FU	65 kW FU
		64,0	86,0
			110 kW FU
			122,0

kVA **reduzierbar bei zu geringer Netz-Anschlussleistung, siehe BAL.** /
kVA can be reduced in case of too little power of the mains, see instruction manual. /
kVA peut être réduit en cas de trop faible puissance du réseau, voir manuel d'instruction. /
kVA riducibili in caso di potenza di rete ridotta (si veda manuale uso e manutenzione) /
kVA variable para potencia de red demasiado pequeña, ver Manual de instrucciones. /
kVA reduzível no caso de capacidade da rede elétrica muito baixa, ver manual de
instruções. / Количество кВА может быть сокращено до минимальной общей
потребляемой мощности, см. инструкцию по эксплуатации.



⁹⁾ Weitere Hublastdaten: siehe Betriebsanleitung. / Further hoist load data: see instruction manual. / Autres données de la charge de levage : voir manuel d'instruction. /
Altri dati sui carichi sollevati: consultare il manuale d'istruzione. / Alturas bajo granco superiores según manual. / Outras tabelas de carga: consultar manual de instruções. /
Другие данные по весу поднимаемых грузов: см. инструкцию по эксплуатации.

Kranoberteil		Upper part of crane / Partie supérieure de grue / Parte superiore della gru / Parte superior grúa / Parte superior do guindaste / Верхняя часть крана	L (m)	B (m)	H (m)	kg ⁽¹⁰⁾		
Pos. Item Rep Voce Pos. Ref. Поз.	Anz. Qty. Qte. Qta. Cant. Cant. Кол-во	Drehbühne kpl. mit Kugeldrehkranz und KUD-Auflage 21 HC 290 mit Klappspitze, Kabine und Schaltschrank mit Podesten / Slewing platform complete with slewing ring and slewing ring support 21 HC 290 with folding jib, cabin and switch cabinet with platforms / Plate-forme tournante complète avec couronne d'orientation et pivot d'orientation 21 HC 290 avec flèche pliante, cabine et armoire électrique avec plates-formes / Piattaforma girevole con ralla e supporto ralla 21 HC 290 con punta ribaltabile, cabina e quadro elettrico con pedane / Plataforma giratoria completa con corona de rotación y asiento de pista 21 HC 290 con punta abatible y armario eléctrico con plataforma / Plataforma de giro completa com coroa de giro e assento da coroa 21HC 290, com lança dobrável, cabine e painel elétrico com plata- formas / Поворотная платформа в сб. с шариковым поворотным кругом и рамой ОПУ 21 HC 290 с откидным кронштейном, каби- ной и распределительным электрошкафом с площадками			6,57	2,42	2,55	11800
1	1							
1a	1	Drehbühne mit Kugeldrehkranz und KUD-Auflage 21 HC 290 / Slewing platform with slewing ring and slewing ring support 21 HC 290 / Plate-forme tournante avec couronne d'orientation et pivot d'orientation 21 HC 290 / Piattaforma girevole con ralla e supporto ralla 21 HC 290 / Plataforma giratoria con corona de rotación y asiento de pista 21 HC 290 / Plataforma de giro com coroa de giro e assento da coroa 21 HC 290 / Поворотная платформа с шариковым поворотным кругом и рамой ОПУ 21 HC 290			3,67	2,39	2,45	7050
1b	1	Schaltschrank mit Podest / Switch cabinet with platform / Armoire électrique avec plate-forme / Quadro elettrico con pedana / Armario eléctrico con plataforma / Armário elétrico com plataforma / Электрошкаф с площадкой			2,31	2,19	1,95	1550
1c	1	Kabine mit Podest / Cabin with platform / Cabine avec plate-forme / Cabina con pedana / Cabina con plataforma / Cabina com plataforma / Кабина с площадкой			2,40	2,09	2,47	1700
1d	1	Klappspitze / Folding jib head / Pointe de flèche pliante / Punta ribaltabile / Pluma / Ponta da lança dobrável / Откидной кронштейн			1,86	1,45	2,34	1500
2	1	Gegenausleger lang / Counter-jib, long / Contre-flèche longue / Controffrecia lunga / Contrapluma larga / Contra-lança, longa / Консоль противовеса, длинная			11,89	2,33	3,01	16100
2a	1	Gegenausleger kurz / Counter-jib, short / Contre-flèche courte / Controffrecia corta / Contrapluma corta / Contra-lança, curta / Консоль противовеса, короткая			11,89	2,33	2,67	12600
2b	1	Gegenausleger-Zwischenstück / Intermediate counter-jib section / Elément interm. de contre-flèche / Spezzone di controbraccio / Tramo intermedio de contrapluma / Peça suplementar da contra- lança / Промежуточная секция консоли противовеса			6,26	1,85	2,45	3500
3	1	Ausleger-Anlenkstück / Jib heel section / Pied de flèche / Sezione articolata braccio / Pluma tramo primero / Base articulada de lança / Корневая секция стрелы			11,92	1,28	2,53	① 5300
4	1	Ausleger-Zwischenstück / Intermediate jib section / Elément intermédiaire de flèche / Sezione intermedia braccio / Tramo intermedio pluma / Peça suplementar da lança / Промежуточная секция стрелы			10,65 5,64	1,28 1,28	2,48 2,47	② 2700 ③ 1150
5	1	Ausleger-Zwischenstück / Intermediate jib section / Elément intermédiaire de flèche / Sezione intermedia braccio / Tramo intermedio pluma / Peça suplementar da lança / Промежуточная секция стрелы			11,94	1,28	2,45	④ 2050
6	1	Ausleger-Zwischenstück / Intermediate jib section Elément intermédiaire de flèche / Sezione intermedia braccio / Tramo intermedio pluma / Peça suplementar da lança / Промежуточная секция стрелы			5,28 10,25 10,23 10,22 3,22 2,78	1,28 1,28 1,28 1,28 1,28 1,28	1,95 1,95 1,94 1,93 1,93 1,95	⑤ 760 ⑥ 1280 ⑦ 850 ⑧ 660 ⑨ 240 ⑩ 460
7	1	Ausleger-Kopfstück / Jib head section / Pointe de flèche / Punta braccio / Tramo punta de pluma / Cabeça de lança / Концевая секция стрелы			1,91	1,28	2,12	⑪ 260
8	1	Laufkatze und Lsthaken / Trolley and hook / Chariot de distribution et crochet / Carrello con gancio / Carrito y gancho / Carro de ponte e gancho / Грузовая тележка и грузовой крюк			2,06	1,62	1,71	810
9	1	Fahrkorb / Maintenance cage / Nacelle d'entretien / Cestello di manutenzione / Plataforma de mantenimiento / Передвижная платформа			0,66	0,57	1,17	25

Pos. Anz.
Item Qty.
Rep Qte.
Voce Qta.
Pos. Cant.
Ref. Cant.
Поз. Кол-во

				L (m)	B (m)	H (m)	kg ⁽¹⁰⁾		
Turm Tower/Mât/Torre Torre/Torre/Башня									
10	1	Turmstück / Tower section / Élément de mât / Elemento di torre / Tramo torre / Torre / Башенная секция	 	 	21 HC 290 TS-0414c 4,14 21 HC 290 TS-0414cr 4,14 21 HC 290 TS-1242c 12,42 24 HC 420 TS-0290c 3,19 24 HC 420 TS-0580c 6,09 24 HC 420 TS-1160 11,90 24 HC 630 TS-0290c 3,38 24 HC 630 TS-0580c 6,28 24 HC 630 TS-1160 12,10	4,14 2,30 2,30 2,30 2,45 2,45 2,45 2,45 2,45 2,45	2,30 2,30 2,30 2,45 2,45 2,45 2,45 2,45 2,45	2500 2950 6100 2950 4500 7200 4050 6450 10750	
11	1	Grundturmstück / Base tower section / Mât de base / Elemento di torre base / Tramo base / Peça de base de torre / Секция основания			21 HC 290 TSB-1242c 12,42 24 HC 630 TSB-1242c 12,42 24 HC 630 TSB-1242r 12,42	12,42 2,68 2,68	2,30 2,68 2,68	8200 14500 17300	
12	1	Kletterturmstück / Climbing tower section / Élément de hissage de mât / Elemento torre di telescopaggio / Tramo de trepado / Tramo de telescopagem / Секция самоподъема			21 HC 290 ECTS-0414 4,14	4,14	2,30	2,45	3300
13	1	Übergangsrahmen / Transition frame / Cadre de raccordement / Adattatore torre / Chasis de unión / Quadro adaptador / Переходная рама			21 HC 290 – 24 HC 630 TF-0080	3,16	2,85	1,08	3700
Klettereinrichtung Climbing equipment / Equipement de télescopage / Attrezzatura per allungamento della gru / Equipo de trepado / Acessórios p. subida no edifício / Обойма наращивания									
14	1	Führungsstück kpl., geteilt / Guide section cpl., split / Cage télescopique cpl., devisée / Gabbia de sopraelevazione compl., suddivisa / Torre de montaje completa, dividida / Peça de guia compl., subdividida / Направляющая секция в сб., разъемная			21 HC 290 ECGS 24 HC 630 ECGS	8,39 12,39	2,75 2,78	2,70 (3,04) 1,58	5800 8550
15	1	Hydraulikanlage, Stütz- und Klettertraverse / Hydraulic unit, supporting and climbing crossmembers / Système hydraul. avec traverses d'appui et de télescop. / Sist. idraul., traversa di appoggio e allugam. gru / Sistema hidráulico con traviesa de apoyo y trepado / Instalação hidráulica, travessa de apoio e subida / Гидроагрегат, стойка-упор и траверса обоймы наращивания			21 HC 290 24 HC 630	2,10 2,60	1,25 1,50	1,00 1,00	1150 1900
Unterwagen Undercarriage / Châssis / Carro / Carro con mástil / Carro de guindaste / Опорная рама									
16	4	Ausgleichsschwinge mit Schwingenlager / Pivot for wheel box / Chape pour bogie / Bilanciere di equilibratura con cuscinetto bilanciere / Balancin / Balancim com suporte / Балансир с шарнирной опорой			24 HC 630	1,60	0,72	1,48	1470
17	2	Fahrschemel mit Antrieb / Rail bogie with drive / Bogie moteur / Telaio con gruppia propulsore / Caja rodillo motriz / Quadra sem grupa de propulsão / Подрамник с приводом			21 HC 290 24 HC 630	1,63 (1,46) 1,45	0,92 (0,84) 0,82	0,95 (0,87) 0,72	1690 (920) 1200
18	2	Fahrschemel ohne Antrieb / Rail bogie without drive / Bogie fou / Telaio senza gruppia propulsore / Caja rodillo conducido / Quadra com grupa de propulsão / Подрамник без привода			21 HC 290 24 HC 630	1,37 (1,15) 1,30	0,62 (0,60) 0,40	0,95 (0,87) 0,72	1340 (880) 950
19	2	Tragholm lang / Long support arm / Longeron long / Longherone lungo / Brazo soporte largo / Travessa comprida / Несущая балка, длинная			21 HC 290 24 HC 630	9,10 (11,95) 7,32 (5,91)	0,80 (0,82) 0,92 (0,92)	0,80 (0,80) 0,93 (0,93)	1650 (2200) 2330 (1980)
20	2	Tragholm kurz / Short support arm / Longeron court / Longherone corto / Brazo soporte corto / Travessa curta / Несущая балка, короткая			21 HC 290 24 HC 630	4,45 (5,58) 7,14 (5,73)	0,77 (0,65) 0,92 (0,80)	0,77 (0,77) 0,90 (0,90)	800 (1040) 2180 (1780)
21	2+2	Randträger / Border support / Traverse / Supporti base Traviesas / Apoio de bordo / Стяжная балка			21 HC 290 24 HC 630	5,46 – 5,40 (7,52 – 7,46) 9,30 (7,30)	0,11 – 0,18 (0,10 – 0,17) 0,24 (0,14)	0,16 – 0,38 (0,10 – 0,38) 0,41 (0,14)	175 – 525 (370 – 915) 870 (400)
22	4	Stützholm / Support strut / Hauban de châssis / Correnti di appoggio / Tirante vertical / Travessa de apoio / Опорный подкос			21 HC 290 24 HC 630	4,14 (6,55) 6,98 (6,05)	0,18 (0,22) 0,26 (0,26)	0,25 (0,25) 0,39 (0,39)	320 (600) 1190 (1140)
23	1	Unterwagen-Turmstück / Undercarriage tower section / Mât de châssis / Elemento di torre del carro / Tramo de carro / Peça de torre do chassis / Опорная башенная секция			21 HC 290 24 HC 630	3,73 (6,70) 6,61	2,62 (2,53) 2,44	2,62 (2,53) 2,44	2920 (4030) 7930
24		Kleinteile, Seile und Abspannungen / Small parts, ropes and holding bars / Accessoires, câbles et tirants / Accessori, funi e attrezzi di ancoraggio / Despieces, cables y tirantes / Acessórios, cabos e peças de ancoragem / Мелкие детали, Канаты и Пристежки			21 HC 290 24 HC 630	9,00	1,60	1,00	4000

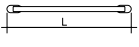
Pos. Anz.
Item Qty.
Rep. Qte.
Voce Qta.
Pos. Cant.
Ref. Cant.
Поз. Кол-во

				L (m)	B (m)	H (m)	kg ¹⁰⁾	
Fundamentkreuz		Cruciform base/Châssis en croix/Crociera/ Carro de guindaste/Base cruciforme/Фундаментная крестовина						
25	2	Hauptträger / Main beam / Poutre principale / Traversa portante / Viga principal / Travessa comprida / основная балка		24 HC 420 CB-0600	9,20	1,10	1,53	8600
26	4	Randträger / Border support / Traverse / Supporti base / Traviesa / Apoio de bordo / Стяжная балка		24 HC 420 CB-0600	5,50	0,25	0,64	420
27	4	Adapter HC-Turm / Adapter for HC tower / Adaptateur pour mât HC / Adattatore torre HC / Tramo transición HC / Adaptador para torre HC / Переходной элемент башни HC		24 HC 420 CB-0600	0,60	0,60	0,70	315

() **Angaben in Klammern gelten für 8 m-Unterwagen.** / The data in brackets are valid for an undercarriage of 8 m. / Les données techniques indiquées entre parenthèses sont valables pour un châssis de 8 m. / Caratteristiche in (..) valgono per carro di 8 m. / Los datos entre paréntesis son válidos para carro de 8 m. / Características em (..) válidas pelo chassis de 8 m. / Данные в скобках относятся к 8-метровой опорной раме.

¹⁰⁾ **Einzelgewichte** / Single weights / Poids individuels / Singoli pesi / Tramo punta de pluma / Pesos de peças componentes / Индивидуальный вес

Änderungen vorbehalten! / Subject to technical modifications! /
Sous réserves de modifications ! / Con riserva di modifiche! /
¡Sujeto a modificaciones sin previo aviso! / Sujeto a modificaciones! /
С правом внесения изменений!

Sämtliche Angaben erfolgen ohne Gewähr. / This information is supplied without liability. /
Ces renseignements sont sans garantie. / Tutte le indicazioni fornite senza garanzia. /
Declinamos toda responsabilidad derivada de la información proporcionada. / Declinamos
qualquer responsabilidade quanto à informação fornecida. / Все данные указаны без обязательств.

TCS-002373-LBC-01 • EN 14439:2009 – EN 13001-HC1/S2 • BGL C.0.10.0315 • 12.18

Printed in Germany.

Liebherr-Werk Biberach GmbH
Postfach 1663, D-88396 Biberach an der Riss
☎ +49 73 51 41-0, Fax: +49 73 51 41 22 25
www.liebherr.com, E-Mail: info.lbc@liebherr.com

Liebherr Industrias Metálicas, S.A.
Polígono Industrial Agustinos, calle E, E-31014 Pamplona
☎ +34 94829 70-00, Fax +34 94829 70-29
www.liebherr.com, E-Mail: info.lim@liebherr.com